



Figure K  
200  
Total K  
230

Judges Name	
Signature	Number

Flight #  
**WP 1**

wind/vent **R**

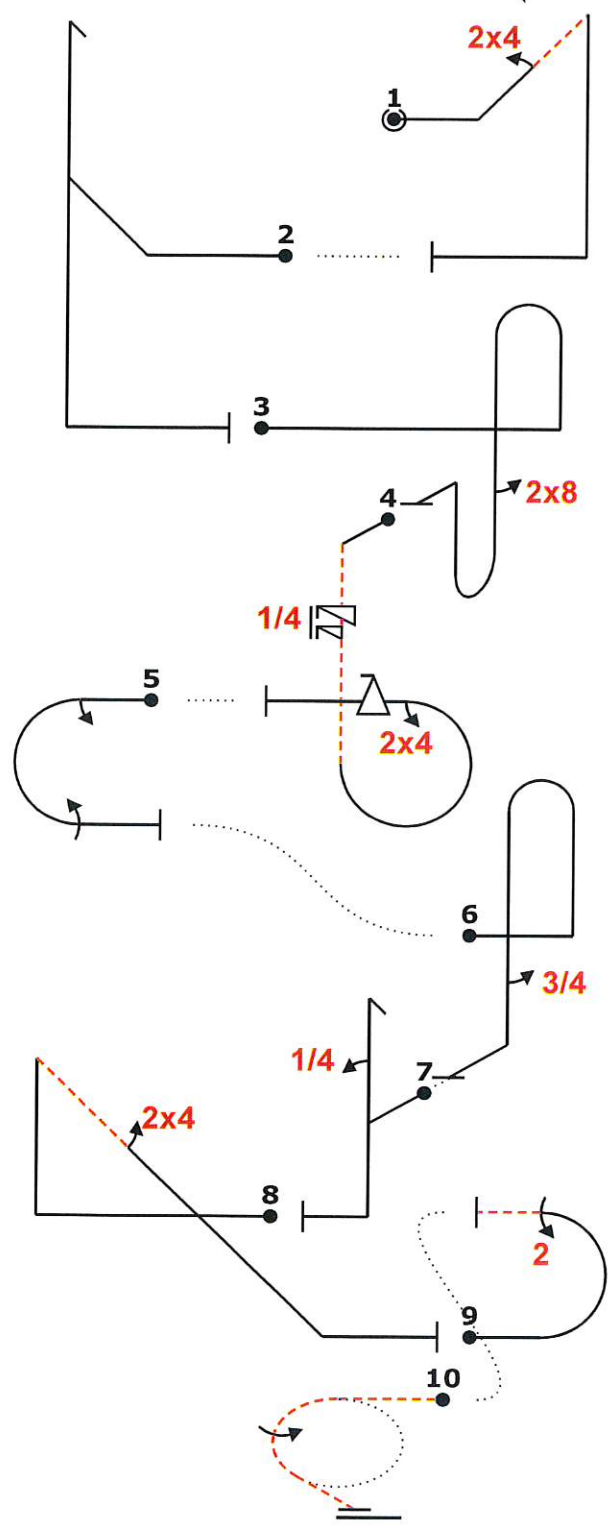

Fig	Grade	Pos	Remarks
1	.		
2	.		
3	.		
4	.		
5	.		
6	.		
7	.		
8	.		
9	.		
10	.		

Positioning  
30

Too Low		Trg Violation	
Too High		Wing Rocks	
Interruptions		Disqual Fig	
Insertions		Other(note...)	

"@0" 2% 24t.''+~ (-5,0) ~+dh('')...'+~ +++bb(8)+ " @A" ,5s1rp24,f> (-3,0) 2a1~ (15,7) b.' '3 (2,-1) "@C" ~4 h> /-+++k24...+ "@B" m22- (2,12) "@E" -1j1-

Fig 1 D	K	Fig 2	K	Fig 3	K	Fig 4 A	K	Fig 5	K	Fig 6	K	Fig 7 C	K	Fig 8	K	Fig 9 B	K	Fig 10 E	K
1.2.3.1	12	5.3.1.1	18	8.8.2.1	19	8.6.4.3	13	7.2.3.3	6	8.4.1.1	13	5.2.1.1	17	1.2.7.1	13	7.2.1.1	6	2.1.3.2	15
9.4.2.2	7			9.8.5.1	3	9.11.1.5	4	9.1.3.2	4	9.1.5.3	6	9.1.1.1	6	9.4.4.2	5	9.2.3.4	9		
<b>SF 7</b>	<b>19</b>	<b>SF 5</b>	<b>18</b>	<b>SF 7</b>	<b>22</b>	<b>SF 3</b>	<b>33</b>	<b>SF 7</b>	<b>18</b>	<b>SF 7</b>	<b>19</b>	<b>SF 5</b>	<b>23</b>	<b>SF 7</b>	<b>18</b>	<b>SF 7</b>	<b>15</b>	<b>SF 2</b>	<b>15</b>

Pilot: Grishina

A/C: Extra 300LC RA-2929G Team: RUS





CIVA Intermediate

Free Known

Deva

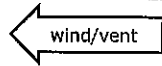

R

Figure K  
200

Total K  
230

Judges Name	
Signature	Number

Flight #

1

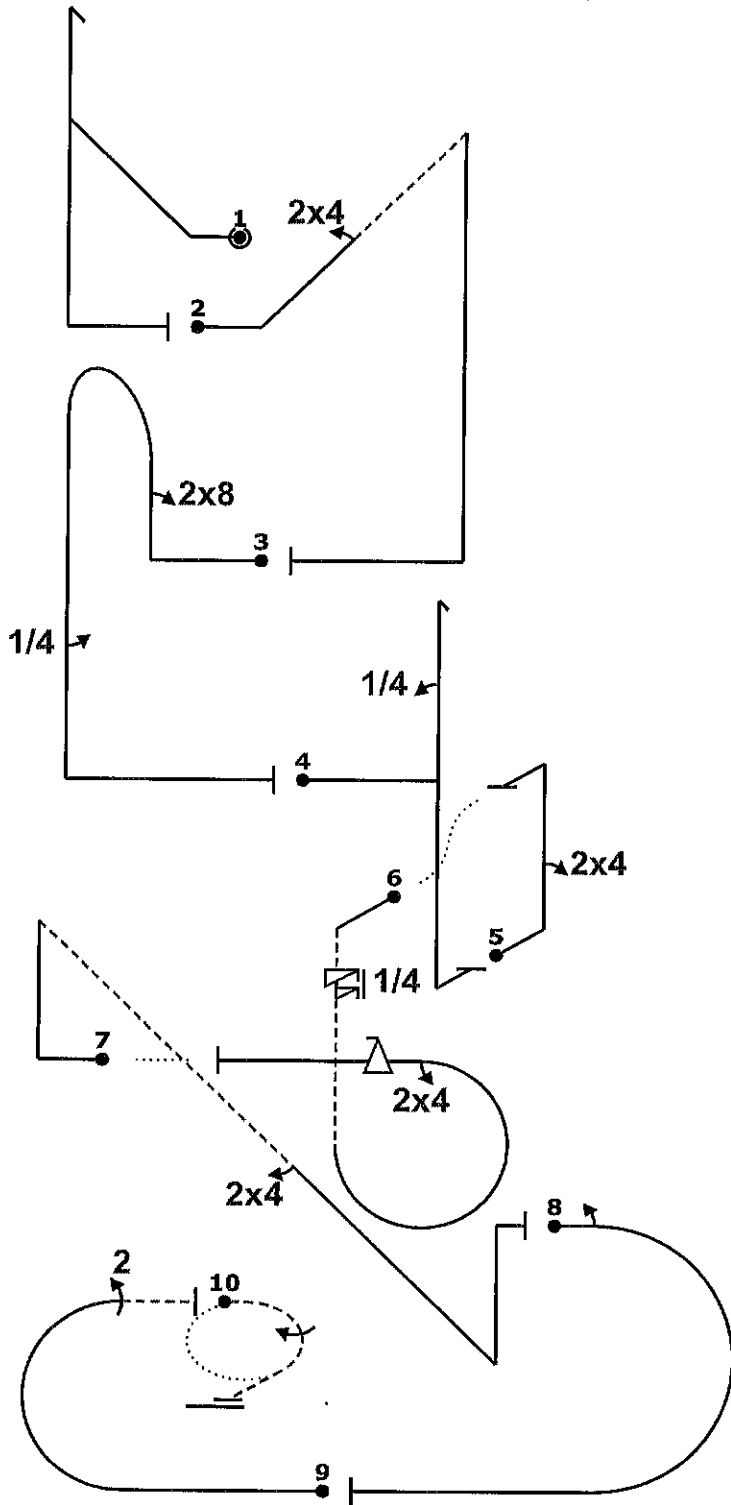

Fig	Grade	Pos	Remarks
1	.		
2	.		
3	.		
4	.		
5	.		
6	.		
7	.		
8	.		
9	.		
10	.		

Positioning  
30 .

Too Low		Trg Violation	
Too High		Wing Rocks	
Interruptions		Disqual Fig	
Insertions		Other(note...)	

ed /'4.'dh...+ "@0" '124...'t.....'Hwv 14% '.....'8'b''1'4' "@C" /...4''h...^ 2X v,24'' (-4,6) "@A" 5X  
"Ss'irp24,f~ (-4,0) n(.....',24.....')+' 14% '.....'24+ "@B" 7% ."m22-" "@E" '.....-1j1-

Fig 1	K	Fig 2 D	K	Fig 3	K	Fig 4 C	K	Fig 5	K	Fig 6 A	K	Fig 7	K	Fig 8	K	Fig 9 B	K	Fig 10 E	K
5.3.1.1	18	1.2.3.1	12	8.4.1.1	13	5.2.1.1	17	1.1.6.1	10	8.6.4.3	13	1.3.12.1	21	7.2.3.3	6	7.2.1.1	6	2.1.3.2	15
		9.4.2.2	7	9.8.1.1	7	9.1.1.1	6	9.4.1.2	9	9.11.1.5	4	9.4.4.2	5	9.1.3.2	4	9.2.3.4	9		
				9.1.5.1	2					9.4.3.2	5								
	18		19		22		23		19	9.9.3.4	11		26		10		15		15
											33								

Pilot: Balazs Kiss

A/C: EXTRA 300 DEEXT

Team: HUN



CIVA	Intermediate
Free Known	

Figure K  
200  
Total K  
230

Judges Name	
Signature	Number

Flight #  
**2**

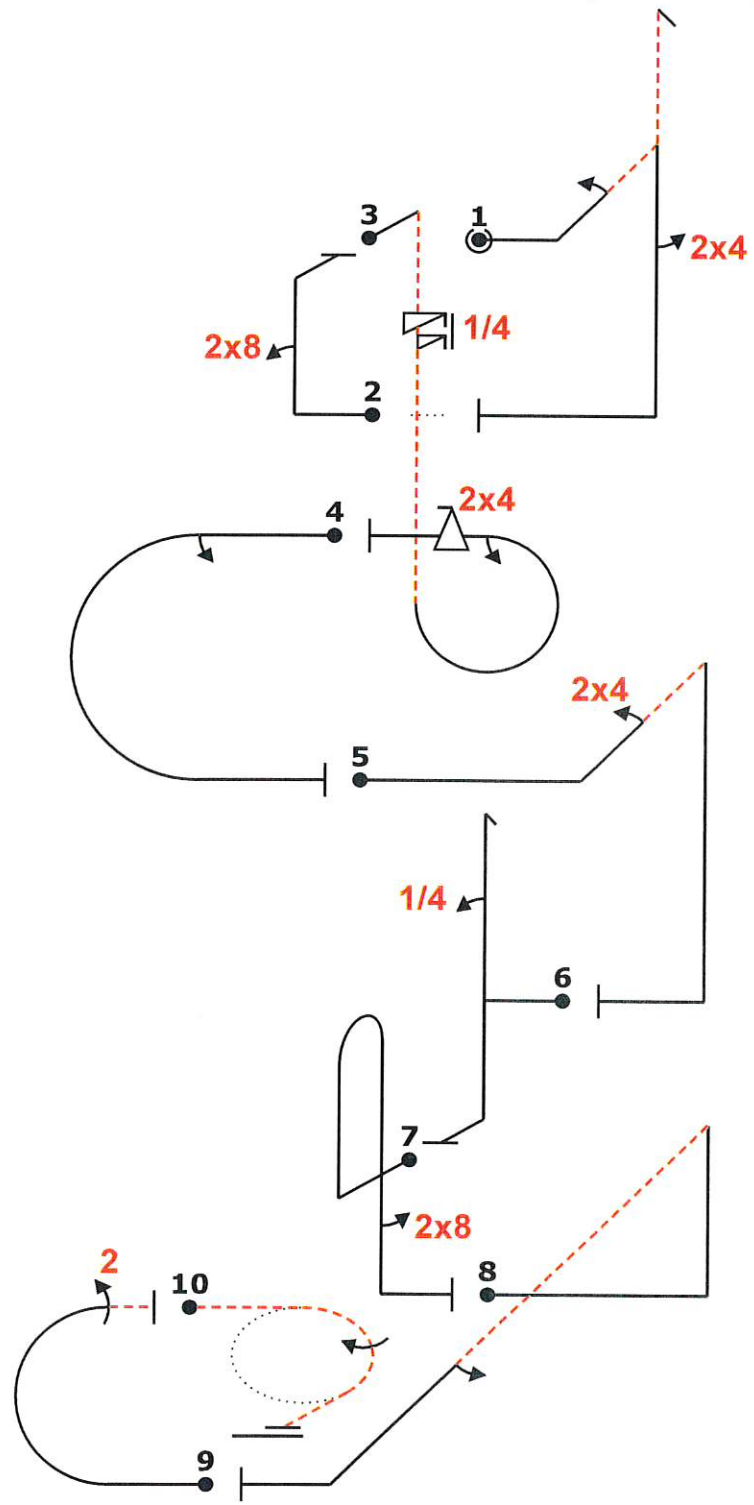
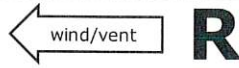

Fig	Grade	Pos	Remarks
1	.		
2	.		
3	.		
4	.		
5	.		
6	.		
7	.		
8	.		
9	.		
10	.		

Positioning  
30

Too Low		Trg Violation	
Too High		Wing Rocks	
Interruptions		Disqual Fig	
Insertions		Other(note...)	

Zdh124... (-3,0) vB "8A" 15s... 124,81" > B3 Za "8B" ... "8C" 147h b... 11k... 21" 31 "8B" m22- "8B" -1j1-

Fig 1	K	Fig 2	K	Fig 3 A	K	Fig 4	K	Fig 5 D	K	Fig 6 C	K	Fig 7	K	Fig 8	K	Fig 9 B	K	Fig 10 E	K
5.3.2.1	24	1.1.6.1	10	8.6.4.3	13	7.2.3.3	6	1.2.3.1	12	5.2.1.1	17	8.4.1.1	13	1.2.7.1	13	7.2.1.1	6	2.1.3.2	15
9.1.2.2	6	9.8.1.1	7	9.11.1.5	4	9.1.3.2	4	9.4.2.2	7	9.1.1.1	6	9.8.5.1	3	9.1.4.2	4	9.2.3.4	9		
9.4.5.2	5			9.4.3.2	5														
				9.9.3.4	11														
	<b>35</b>		<b>17</b>		<b>33</b>		<b>10</b>		<b>19</b>		<b>23</b>		<b>16</b>		<b>17</b>		<b>15</b>		<b>15</b>

Pilot: GLONTARU PETRE

A/C: E300 L YR-EWH

Team: ROU

03/09/2021, 1.



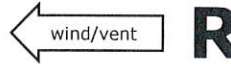

Figure K  
200  
Total K  
230

Judges Name	
Signature	Number

Flight #  
**3**

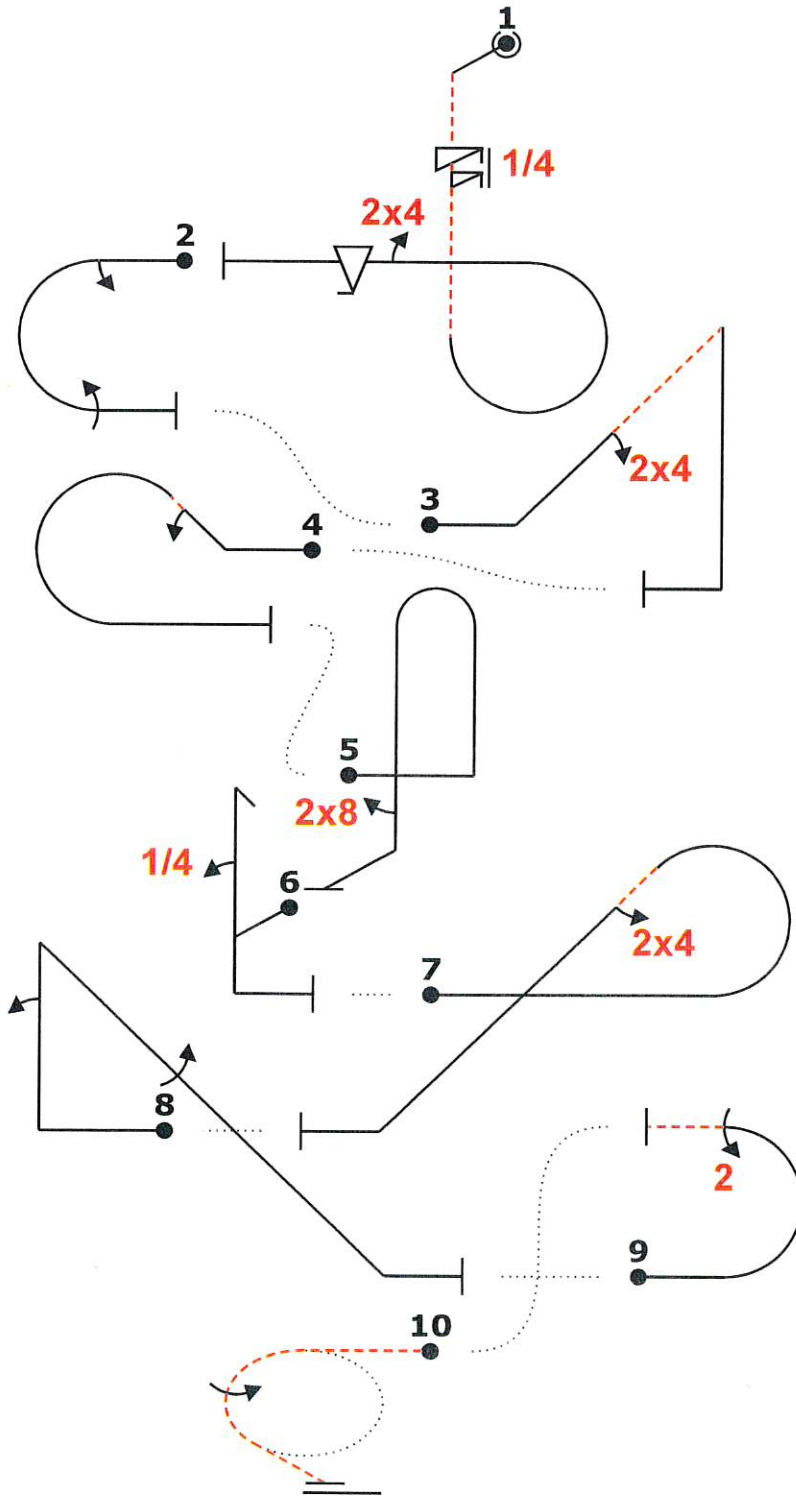

Fig	Grade	Pos	Remarks
1	.		
2	.		
3	.		
4	.		
5	.		
6	.		
7	.		
8	.		
9	.		
10	.		

Positioning  
**30**

Too Low		Trg Violation	
Too High		Wing Rocks	
Interruptions		Disqual Fig	
Insertions		Other(note...)	

ej "GA" 5s1rp... ,24,f> 2a1 (9,6) "GD" ..,24.'t... (-13,-2) ..... 2 "nc" ..... (0,8) b.' ,8 "GC" 4h' (2,0) c  
24...' (-3,0) ~'2 k''1...' (5,0) "GB" m22- (-7,12) "GE" /-1j1-

Fig 1 A	K	Fig 2	K	Fig 3 D	K	Fig 4	K	Fig 5	K	Fig 6 C	K	Fig 7	K	Fig 8	K	Fig 9 B	K	Fig 10 E	K
8.6.4.3	13	7.2.3.3	6	1.2.3.1	12	8.5.2.1	10	8.4.1.1	13	5.2.1.1	17	8.5.6.1	10	1.2.6.1	14	7.2.1.1	6	2.1.3.2	15
9.1.1.1.5	4	9.1.3.2	4	9.4.2.2	7	9.1.2.2	6	9.8.5.1	3	9.1.1.1	6	9.4.4.2	5	9.1.1.2	8	9.2.3.4	9		
9.4.3.2	5	9.1.3.4	8											9.1.4.4	8				
9.9.3.4	11																		
<b>SF 3</b>	<b>33</b>	<b>SF 7</b>	<b>18</b>	<b>SF 7</b>	<b>19</b>	<b>SF 7</b>	<b>16</b>	<b>SF 7</b>	<b>16</b>	<b>SF 5</b>	<b>23</b>	<b>SF 7</b>	<b>15</b>	<b>SF 7</b>	<b>30</b>	<b>SF 7</b>	<b>15</b>	<b>SF 2</b>	<b>15</b>

Pilot: Gurov,

A/C: Sukhoi Su-26 RA-30776 Team: RUS



CIVA Intermediate 09/2021

Programme1

Deva

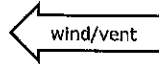

**R**

Figure K  
200

Total K  
230

Judges Name	
Signature	Number

Flight # <b>4</b>
----------------------

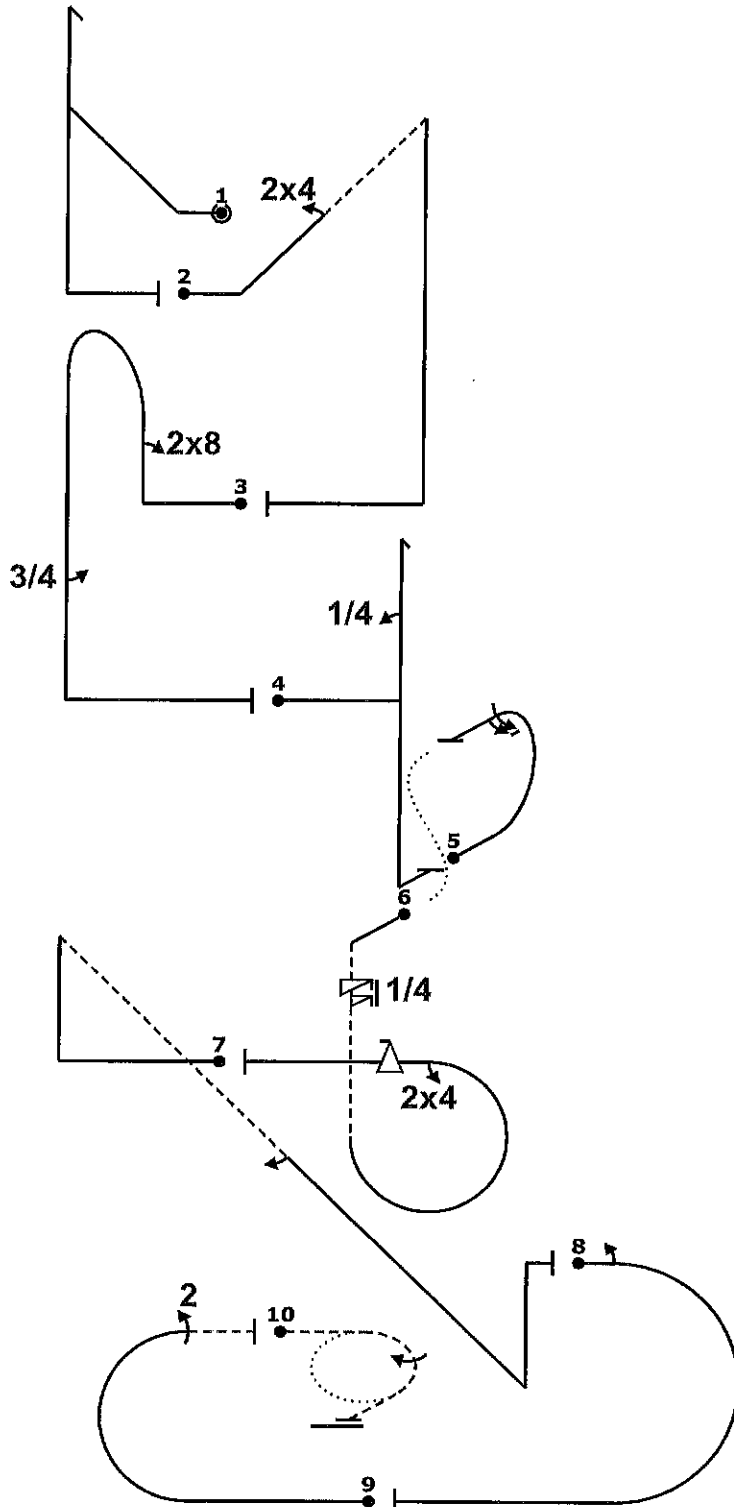

Fig	Grade	Pos	Remarks
1	.		
2	.		
3	.		
4	.		
5	.		
6	.		
7	.		
8	.		
9	.		
10	.		

Positioning  
30

Too Low		Trg Violation	
Too High		Wing Rocks	
Interruptions		Disqual Flg	
Insertions		Other(note...)	

ed /+.'dh...+ "@0" .1'24...t.....'+m 14% '++++'8'b'1'1'3^ "6C" /vnt.4'h...^ 2% m6 (0,12) "6A" 5% '15 s'1rp24,f= mnt+n(.....,2.....)'14% '2a+ 7% "@B" .m22'- "6E" -1j1-

Fig 1	K	Fig 2 D	K	Fig 3	K	Fig 4 C	K	Fig 5	K	Fig 6 A	K	Fig 7	K	Fig 8	K	Fig 9 B	K	Fig 10 E	K
5.3.1.1	18	1.2.3.1	12	8.4.1.1	13	5.2.1.1	17	7.2.2.1	6	8.6.4.3	13	1.3.12.1	21	7.2.3.3	6	7.2.1.1	6	2.1.3.2	15
		9.4.2.2	7	9.8.1.1	7	9.1.1.1	6	9.1.3.6	10	9.1.1.5	4	9.1.4.2	4	9.1.3.2	4	9.2.3.4	9		
				9.1.5.3	6					9.4.3.2	5								
										9.9.3.4	11								
	18		19		26		23		16		33		25		10		15		15

Pilot: János Sonkoly

A/C: EXTRA300 DEEXT

Team: HUN



CIVA Intermediate

Free Known

wind/vent ←

**R**

Figure K  
200  
Total K  
230

Judges Name  
Signature  
Number

Flight #  
**5**

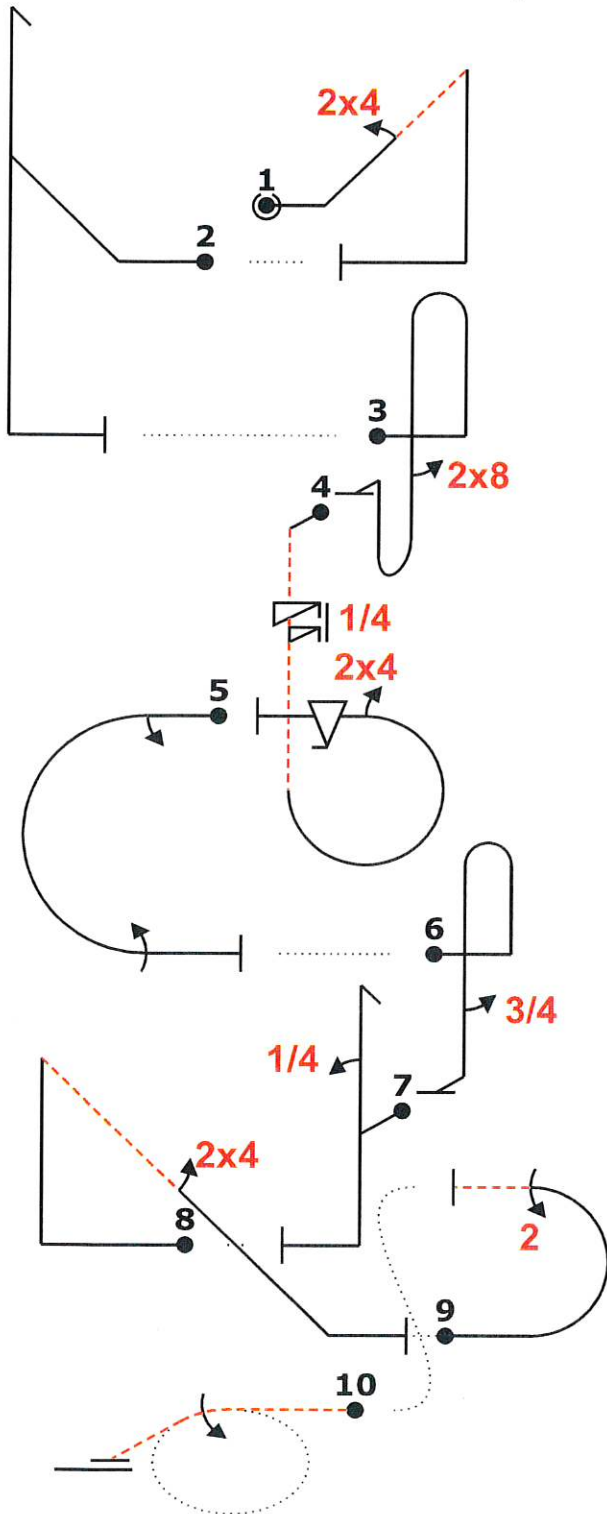

Fig	Grade	Pos	Remarks
1	.		
2	.		
3	.		
4	.		
5	.		
6	.		
7	.		
8	.		
9	.		
10	.		

Positioning  
30

Too Low		Trg Violation	
Too High		Wing Rocks	
Interruptions		Disqual Fig	
Insertions		Other(note...)	

"@D" 3% ""+24t~ (-3,0) dh...~ (10,0) -3% .bb("8")+ ""@A" ""+5s1rp,24,f+""> 6% ""2a1+ (6,0) -4% b.. '3'"+ ""@C" ""+4h> (-1,0) +k''24. (-2,0) "@B" m22- (-1,12) "@E" -1j1-

Fig 1 D	K	Fig 2	K	Fig 3	K	Fig 4 A	K	Fig 5	K	Fig 6	K	Fig 7 C	K	Fig 8	K	Fig 9 B	K	Fig 10 E	K
1.2.3.1	12	5.3.1.1	18	8.8.2.1	19	8.6.4.3	13	7.2.3.3	6	8.4.1.1	13	5.2.1.1	17	1.2.7.1	13	7.2.1.1	6	2.1.3.2	15
9.4.2.2	7			9.8.5.1	3	9.11.1.5	4	9.1.3.2	4	9.1.5.3	6	9.1.1.1	6	9.4.4.2	5	9.2.3.4	9		
	19		18		22	9.4.3.2	5	9.1.3.4	8		19		23		18		15		15
						9.9.3.4	11												
							33												

Pilot: Dariusz Mazur

A/C: Extra 330 SP-DMK

Team: POL



CIVA	Intermediate
Free Known	

Figure K  
200  
Total K  
230

Judges Name	
Signature	Number

Flight #
6

wind/vent **R**

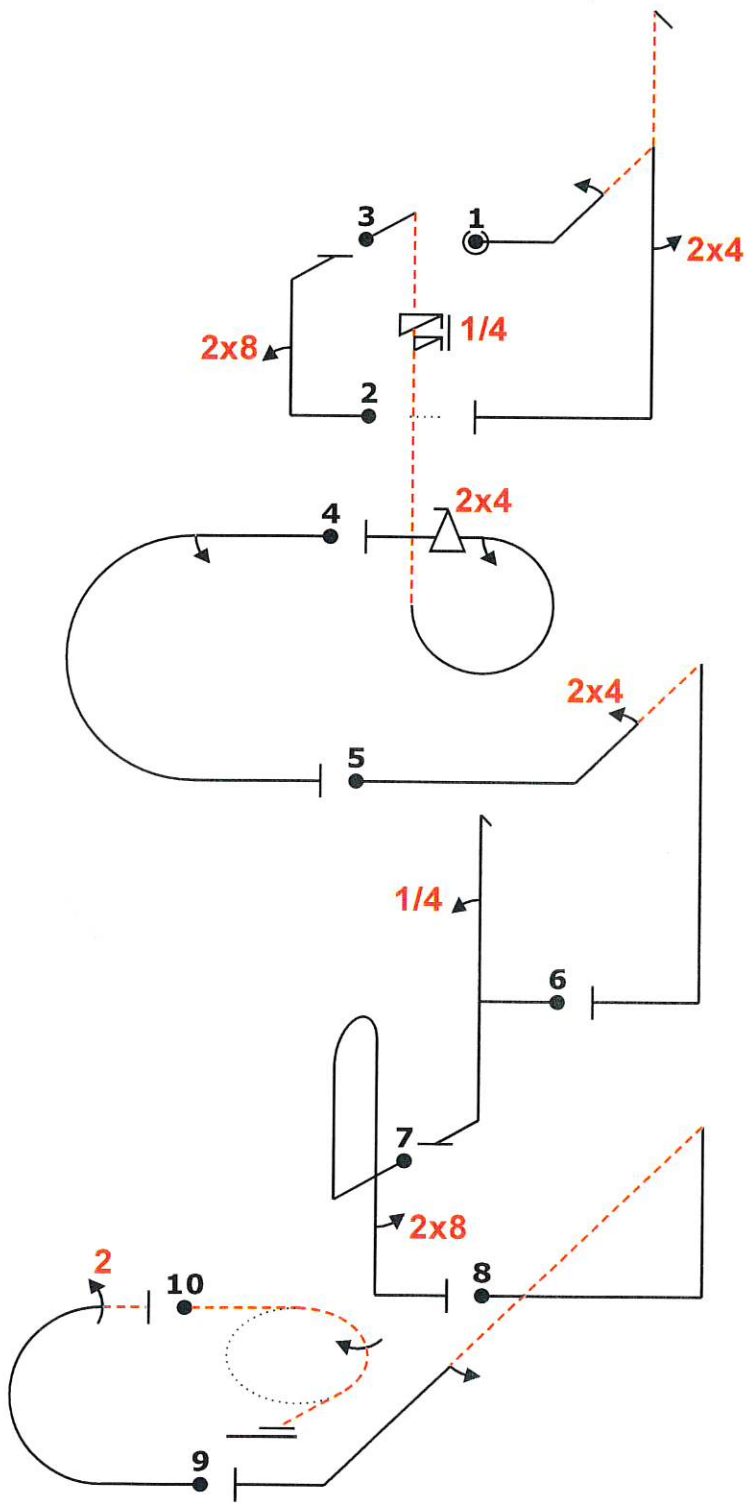

Fig	Grade	Pos	Remarks
1	.		
2	.		
3	.		
4	.		
5	.		
6	.		
7	.		
8	.		
9	.		
10	.		

Positioning  
30

Too Low		Trg Violation	
Too High		Wing Rocks	
Interruptions		Disqual Fig	
Insertions		Other(note...)	

2ah1124...11++ (-2,0) y8^ "0A" 115s..1ixp1"24,2+1"> 9- 2a "0D" +++124"b..... "gcb" 114'h' b..11g+11 -- ++k...12"1- 3: "0B" m22-11 "0B" -1j1-

Fig 1	K	Fig 2	K	Fig 3 A	K	Fig 4	K	Fig 5 D	K	Fig 6 C	K	Fig 7	K	Fig 8	K	Fig 9 B	K	Fig 10 E	K
5.3.2.1	24	1.1.6.1	10	8.6.4.3	13	7.2.3.3	6	1.2.3.1	12	5.2.1.1	17	8.4.1.1	13	1.2.7.1	13	7.2.1.1	6	2.1.3.2	15
9.1.2.2	6	9.8.1.1	7	9.11.1.5	4	9.1.3.2	4	9.4.2.2	7	9.1.1.1	6	9.8.5.1	3	9.1.4.2	4	9.2.3.4	9		
9.4.5.2	5			9.4.3.2	5														
				9.9.3.4	11														
	<b>35</b>		<b>17</b>		<b>33</b>		<b>10</b>		<b>19</b>		<b>23</b>		<b>16</b>		<b>17</b>		<b>15</b>		<b>15</b>

Pilot: DRAGUS LUCIAN

A/C: E300 L YR-EWF

Team: ROU





Figure K  
200  
Total K  
230

Judges Name  
Signature Number

Flight #  
7

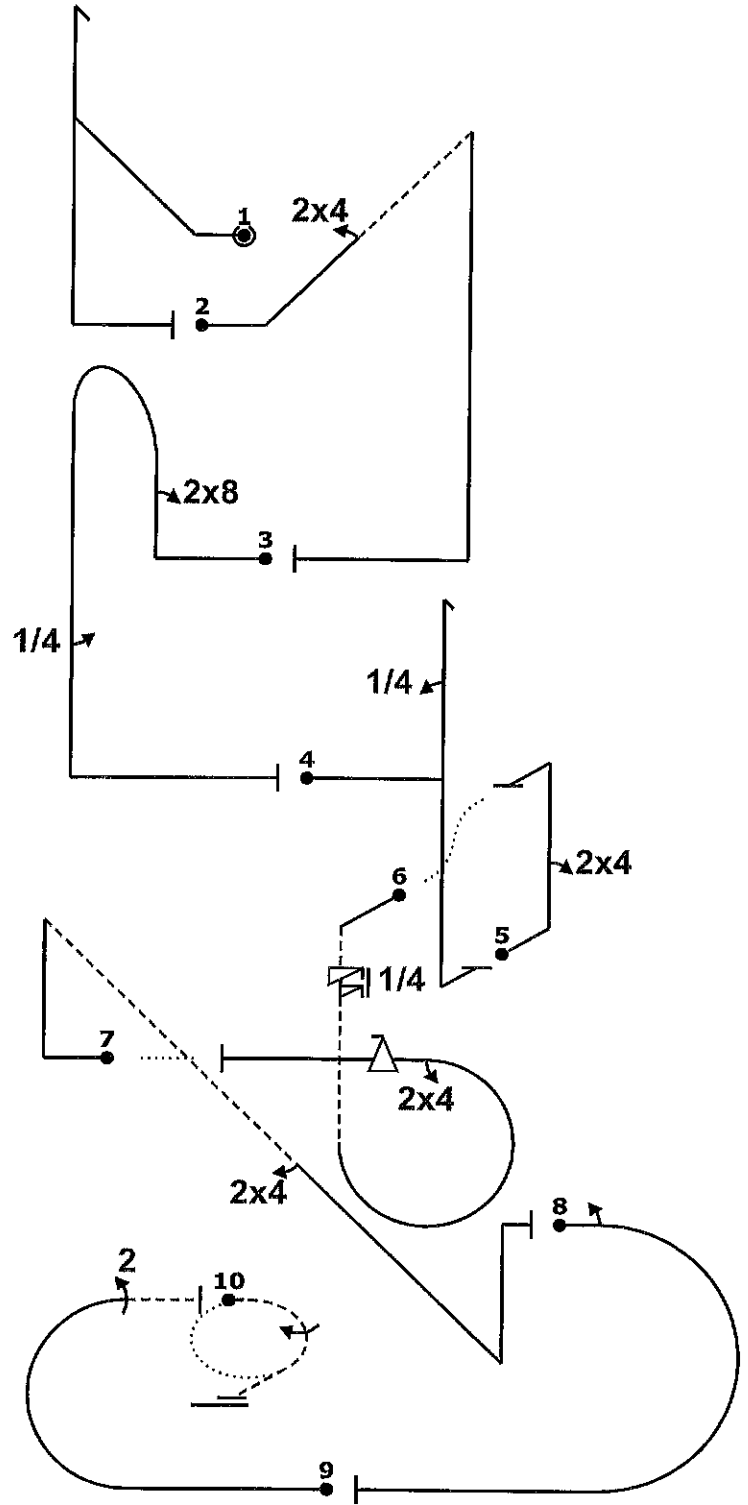
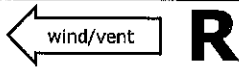

Fig	Grade	Pos	Remarks
1	.		
2	.		
3	.		
4	.		
5	.		
6	.		
7	.		
8	.		
9	.		
10	.		

Positioning  
30 .

Too Low		Trg Violation	
Too High		Wing Rocks	
Interruptions		Disqual Fig	
Insertions		Other(note...)	

ed /+ 'dh...+ "00" . \*\*24...t.....'++++ 14% '++++' 8' b' " | "4^ "0C" /m...4' h... 2% v, 24" (-4,6) "0A" 5%  
"5s" 1rp24, f~ (-4,0) n(.....', 24.....') + " 14% "2a+ "0a" 7% , "m22- "0E" .....-1j1-

Fig 1	K	Fig 2 D	K	Fig 3	K	Fig 4 C	K	Fig 5	K	Fig 6 A	K	Fig 7	K	Fig 8	K	Fig 9 B	K	Fig 10 E	K
5.3.1.1	18	1.2.3.1	12	8.4.1.1	13	5.2.1.1	17	1.1.6.1	10	8.6.4.3	13	1.3.12.1	21	7.2.3.3	6	7.2.1.1	6	2.1.3.2	15
		9.4.2.2	7	9.8.1.1	7	9.1.1.1	6	9.4.1.2	9	9.11.1.5	4	9.4.4.2	5	9.1.3.2	4	9.2.3.4	9		
				9.1.5.1	2					9.4.3.2	5								
										9.9.3.4	11								
	18		19		22		23		19		33		26		10		15		15

Pilot: Tamas Rohacs

A/C: EXTRA 300 DEEXT

Team: HUN

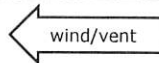

**R**

Figure K  
200  
Total K  
230

Judges Name	
Signature	Number

Flight #  
**8**

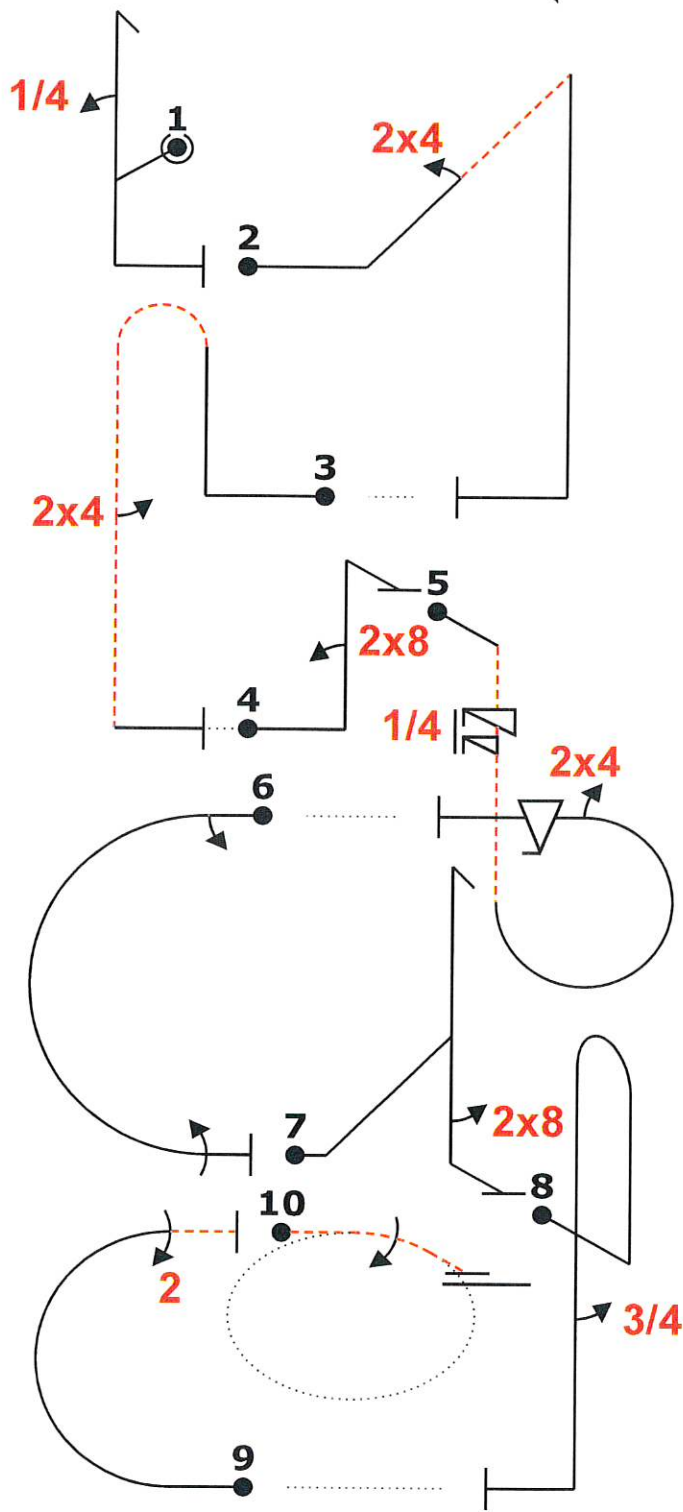

Fig	Grade	Pos	Remarks
1	.		
2	.		
3	.		
4	.		
5	.		
6	.		
7	.		
8	.		
9	.		
10	.		

Positioning  
30

Too Low		Trg Violation	
Too High		Wing Rocks	
Interruptions		Disqual Fig	
Insertions		Other(note...)	

ej (4,3) "@C" 4h "0D" /~124.t... (-2,0) + pb""|24..4" (-2,0) v"|8 "0A" ",5s'irp,24,fr" (-4,0) 10%  
2a1+...+dh8 b...3."+ (-7,0) "0B" 5% "m,22-... "0E" 4% ---1j1-

Fig 1 C	K	Fig 2 D	K	Fig 3	K	Fig 4	K	Fig 5 A	K	Fig 6	K	Fig 7	K	Fig 8	K	Fig 9 B	K	Fig 10 E	K
5.2.1.1	17	1.2.3.1	12	8.4.3.1	15	1.1.6.1	10	8.6.4.3	13	7.2.3.3	6	5.3.1.1	18	8.4.1.1	13	7.2.1.1	6	2.1.3.2	15
9.1.1.1	6	9.4.2.2	7	9.4.5.2	5	9.8.1.1	7	9.1.1.5	4	9.1.3.2	4	9.8.5.1	3	9.1.5.3	6	9.2.3.4	9		
	<b>23</b>		<b>19</b>		<b>20</b>		<b>17</b>	9.4.3.2	5	9.1.3.4	8		<b>21</b>		<b>19</b>		<b>15</b>		<b>15</b>
								9.9.3.4	11										
									<b>33</b>		<b>18</b>								

Pilot: Maciej Kulaszewski

A/C: GenPro HA-XEN

Team: POL

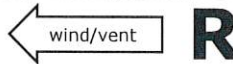

Figure K  
200  
Total K  
230

Judges Name	
Signature	Number

Flight #  
**9**

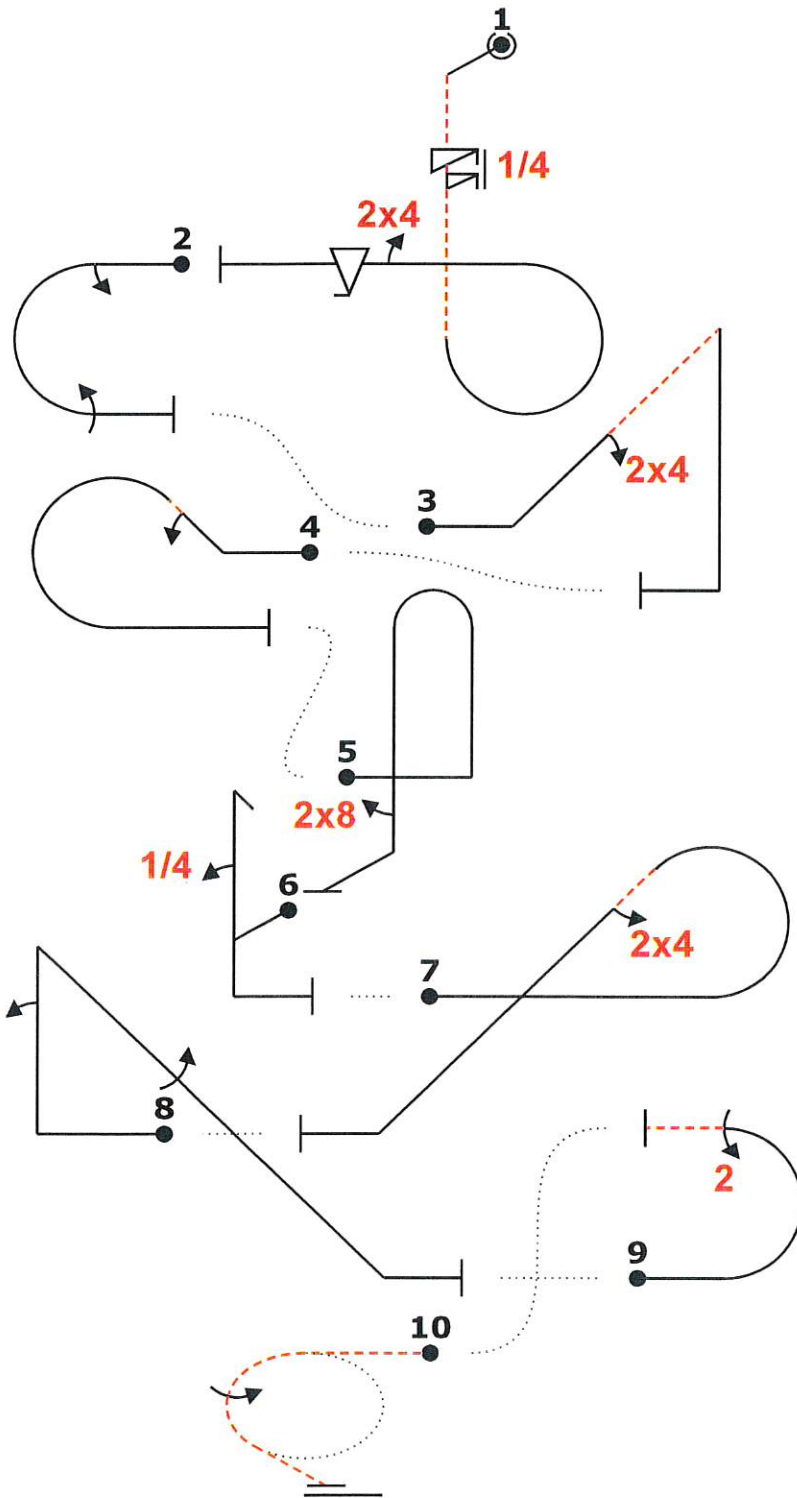

Fig	Grade	Pos	Remarks
1	.		
2	.		
3	.		
4	.		
5	.		
6	.		
7	.		
8	.		
9	.		
10	.		

Positioning  
30

Too Low		Trg Violation	
Too High		Wing Rocks	
Interruptions		Disqual Fig	
Insertions		Other(note...)	

ej "@A" 5sirr..,24,f> 2al (9,6) "@0" .,24.'t.. (-13,-2) ..... 2' rc ..... (0,8) b.'8' "@c" 4h' ..... (2,0) c 24...' (-3,0) ~-2 k'1..' (5,0) "@8" m22- (-7,12) "@E" /-1j1-

Fig 1 A	K	Fig 2	K	Fig 3 D	K	Fig 4	K	Fig 5	K	Fig 6 C	K	Fig 7	K	Fig 8	K	Fig 9 B	K	Fig 10 E	K
8.6.4.3	13	7.2.3.3	6	1.2.3.1	12	8.5.2.1	10	8.4.1.1	13	5.2.1.1	17	8.5.6.1	10	1.2.6.1	14	7.2.1.1	6	2.1.3.2	15
9.11.1.5	4	9.1.3.2	4	9.4.2.2	7	9.1.2.2	6	9.8.5.1	3	9.1.1.1	6	9.4.4.2	5	9.1.1.2	8	9.2.3.4	9		
9.4.3.2	5	9.1.3.4	8											9.1.4.4	8				
9.9.3.4	11																		
<b>SF 3</b>	<b>33</b>	<b>SF 7</b>	<b>18</b>	<b>SF 7</b>	<b>19</b>	<b>SF 7</b>	<b>16</b>	<b>SF 7</b>	<b>16</b>	<b>SF 5</b>	<b>23</b>	<b>SF 7</b>	<b>15</b>	<b>SF 7</b>	<b>30</b>	<b>SF 7</b>	<b>15</b>	<b>SF 2</b>	<b>15</b>

Pilot: Bravkov,

A/C: Sukhoi Su-26 RA-30776 Team: RUS



Figure K  
200  
Total K  
230

Judges Name  
Signature Number

Flight #  
10

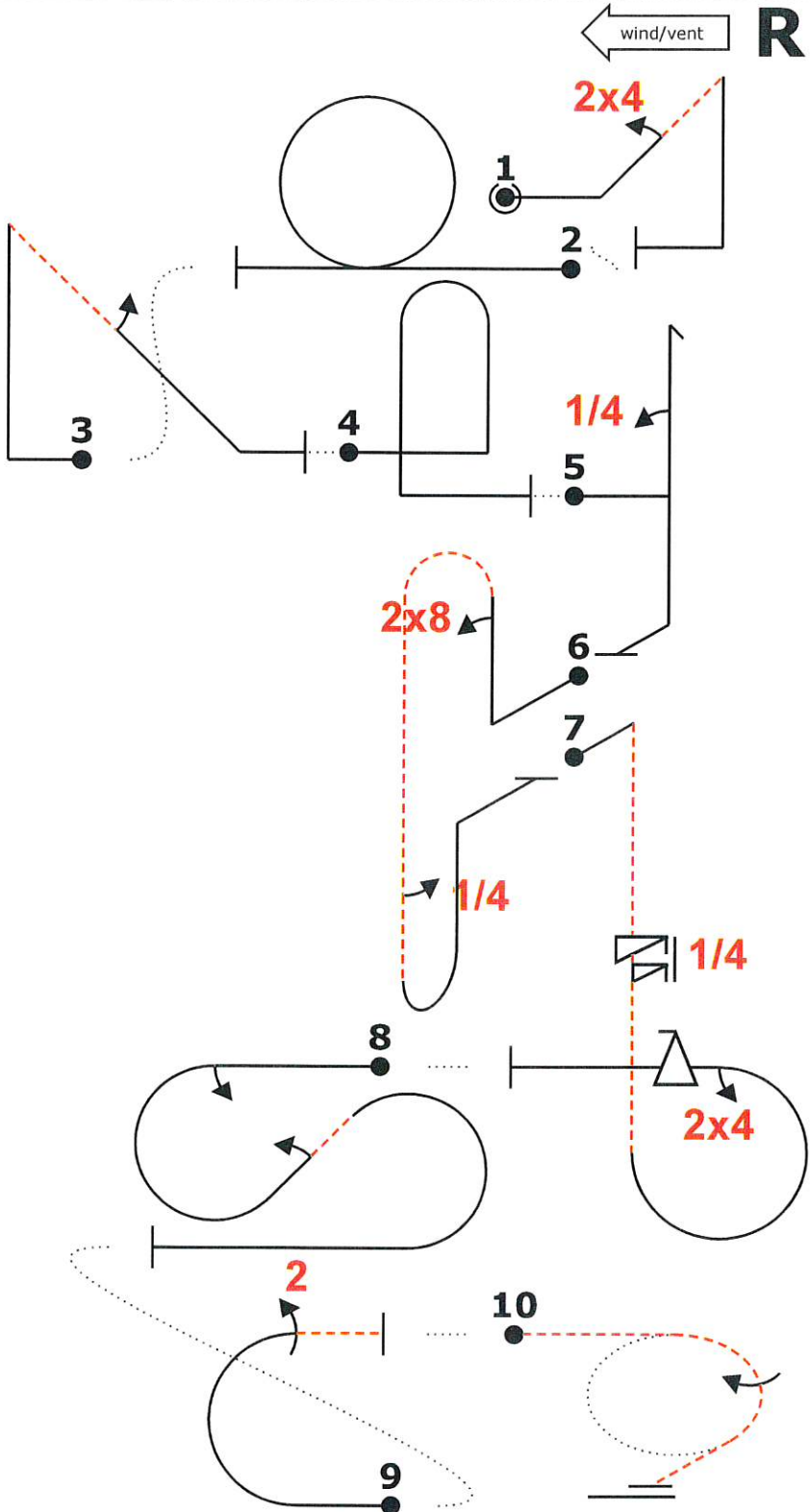

Fig	Grade	Pos	Remarks
1	.		
2	.		
3	.		
4	.		
5	.		
6	.		
7	.		
8	.		
9	.		
10	.		

Positioning  
30

Too Low		Trg Violation	
Too High		Wing Rocks	
Interruptions		Disqual Fig	
Insertions		Other(note...)	

"@D" 24t (1,1) to (-3,9) '+k' 2+ (-2,0) 'b' (-2,0) "@C" 4h 8pbb(.4) "@A" ..5snp24,f~ (-2,0) -1% .....  
2iac(2)+ (15,12) "gB" m22- (2,0) "gE" ~-1j-

Fig 1 D	K	Fig 2	K	Fig 3	K	Fig 4	K	Fig 5 C	K	Fig 6	K	Fig 7 A	K	Fig 8	K	Fig 9 B	K	Fig 10 E	K
1.2.3.1	12	7.4.1.1	10	1.2.7.1	13	8.4.1.1	13	5.2.1.1	17	8.8.6.1	21	8.6.4.3	13	7.5.5.3	15	7.2.1.1	6	2.1.3.2	15
9.4.2.2	7			9.1.4.2	4			9.1.1.1	6	9.8.1.1	7	9.11.1.5	4	9.1.3.2	4	9.2.3.4	9		
	19		10		17		13		23		30	9.4.3.2	5	9.1.2.2	6				
												9.9.3.4	11						
													33		25		15		15

Pilot: Oleksandr Lytvynenko

A/C: E300 OM-PWB

Team: UKR



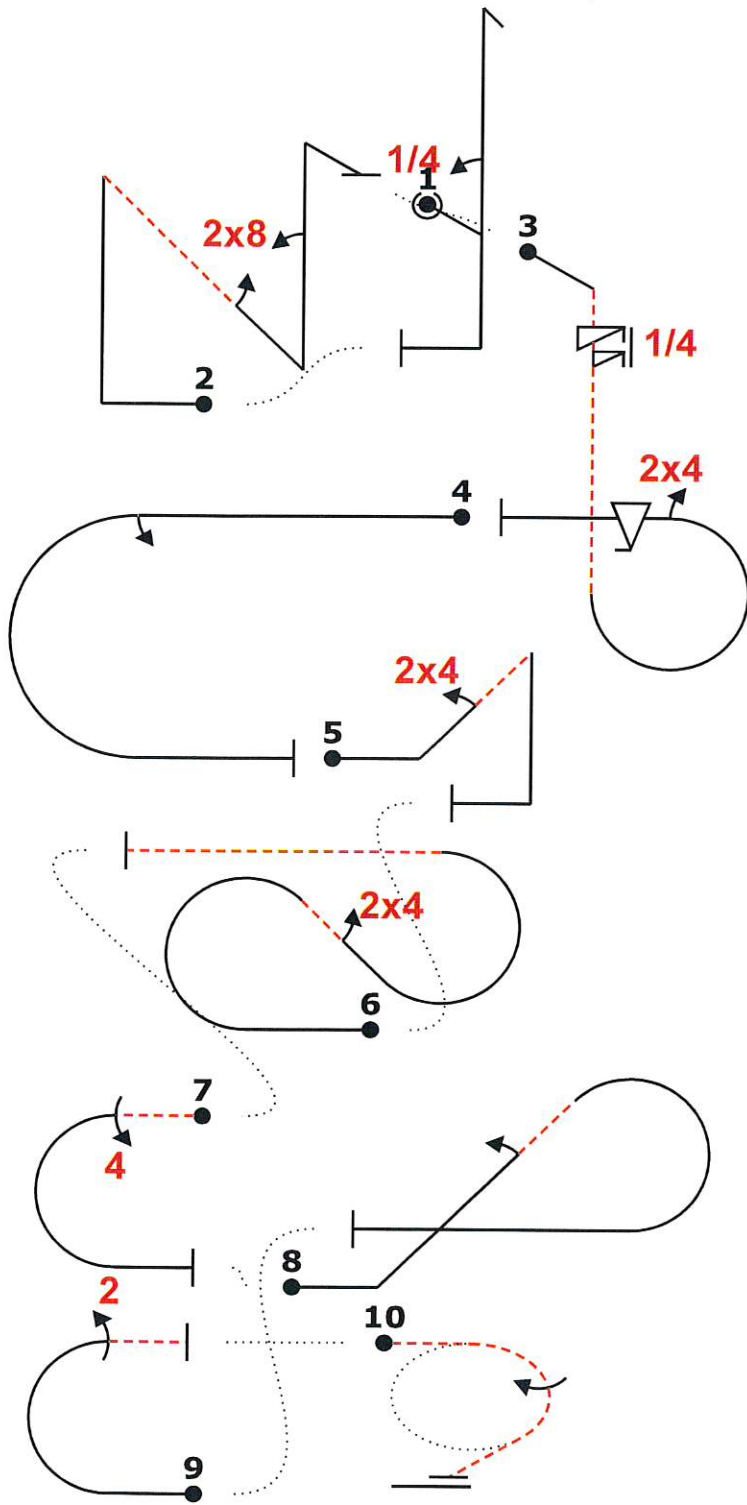
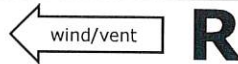

Fig	Grade	Pos	Remarks
1	.		
2	.		
3	.		
4	.		
5	.		
6	.		
7	.		
8	.		
9	.		
10	.		

Positioning **30**

Too Low	<input type="text"/>	Trg Violation	<input type="text"/>
Too High	<input type="text"/>	Wing Rocks	<input type="text"/>
Interruptions	<input type="text"/>	Disqual Fig	<input type="text"/>
Insertions	<input type="text"/>	Other(note...)	<input type="text"/>

ej "@C" /4. 'h> (-6,3) 2% n(2)8 (5,2) "@A" ~' 5s. 'irp,24,f 6% ++2a- "@0" 24t (0,12) .....ac(24)- (8,14) - 44a (1,1) 2rc (-4,14) "@B" m22- (6,0) "@E" /' -1j1-

Fig 1 C	K	Fig 2	K	Fig 3 A	K	Fig 4	K	Fig 5 D	K	Fig 6	K	Fig 7	K	Fig 8	K	Fig 9 B	K	Fig 10 E	K
5.2.1.1	17	1.3.12.1	21	8.6.4.3	13	7.2.3.3	6	1.2.3.1	12	7.5.2.1	15	7.2.1.4	6	8.5.2.1	10	7.2.1.1	6	2.1.3.2	15
9.1.1.1	6	9.1.4.2	4	9.11.1.5	4	9.1.3.2	4	9.4.2.2	7	9.4.4.2	5	9.4.3.4	11	9.1.2.2	6	9.2.3.4	9		
		9.8.1.1	7	9.4.3.2	5														
				9.9.3.4	11														
	<b>23</b>		<b>32</b>		<b>33</b>		<b>10</b>		<b>19</b>		<b>20</b>		<b>17</b>		<b>16</b>		<b>15</b>		<b>15</b>

Pilot: Adrian Willis

A/C: GenPro HA-XEN

Team: GBR



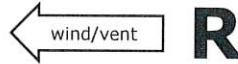

Figure K  
200  
Total K  
230

Judges Name	
Signature	Number

Flight #  
**12**

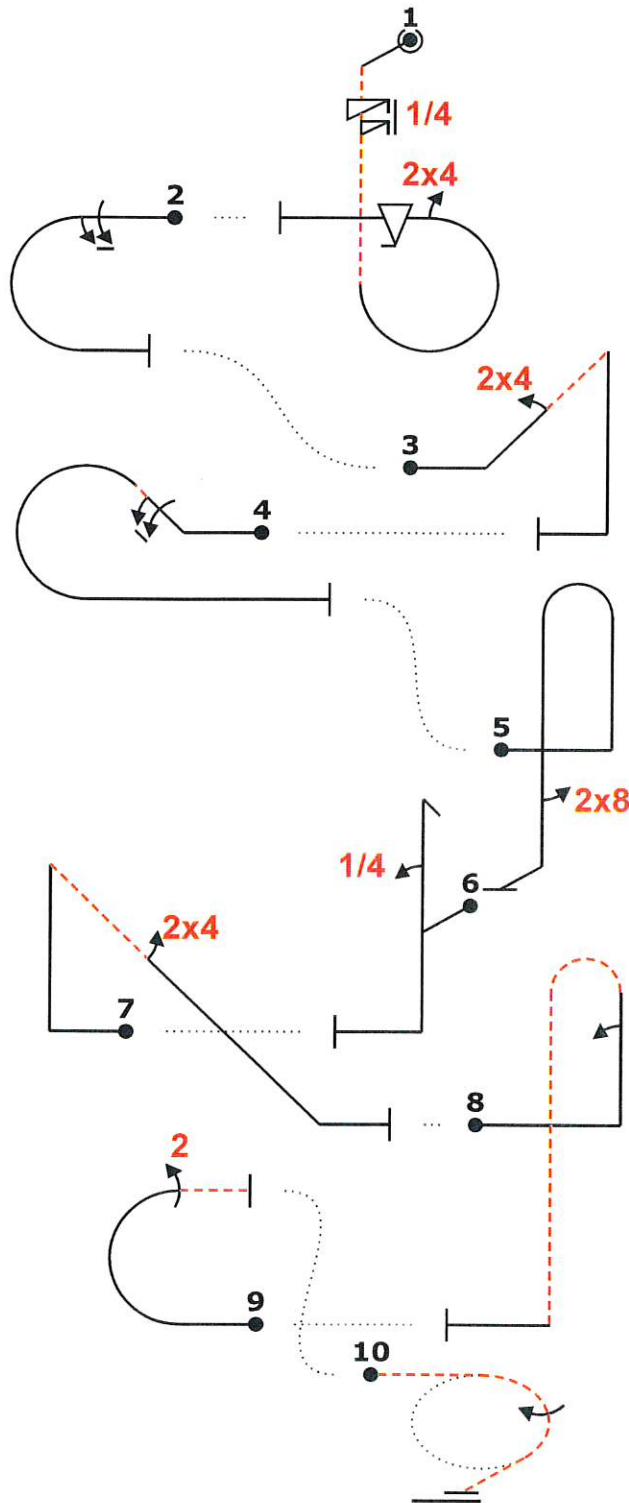

Fig	Grade	Pos	Remarks
1	.		
2	.		
3	.		
4	.		
5	.		
6	.		
7	.		
8	.		
9	.		
10	.		

Positioning  
30

Too Low		Trg Violation	
Too High		Wing Rocks	
Interruptions		Disqual Fig	
Insertions		Other(note...)	

ej "a" 5s'1rp,24,f> (-2,0) 6a (11,7) "aD" '24't. (-12,0) ..... 6'rc (6,9) b.'8s' "aC" 4h-> (-8,0) k2  
4.. (1,0) ~2pb...' (-7,0) "aB" m22- (3,11) "aE" -1j1-

Fig 1 A	K	Fig 2	K	Fig 3 D	K	Fig 4	K	Fig 5	K	Fig 6 C	K	Fig 7	K	Fig 8	K	Fig 9 B	K	Fig 10 E	K
8.6.4.3	13	7.2.3.3	6	1.2.3.1	12	8.5.2.1	10	8.4.1.1	13	5.2.1.1	17	1.2.7.1	13	8.4.3.1	15	7.2.1.1	6	2.1.3.2	15
9.1.1.1.5	4	9.1.3.6	10	9.4.2.2	7	9.1.2.6	12	9.8.5.1	3	9.1.1.1	6	9.4.4.2	5	9.1.1.2	8	9.2.3.4	9		
9.4.3.2	5																		
9.9.3.4	11																		
<b>SF 3</b>	<b>33</b>	<b>SF 7</b>	<b>16</b>	<b>SF 7</b>	<b>19</b>	<b>SF 7</b>	<b>22</b>	<b>SF 7</b>	<b>16</b>	<b>SF 5</b>	<b>23</b>	<b>SF 7</b>	<b>18</b>	<b>SF 7</b>	<b>23</b>	<b>SF 7</b>	<b>15</b>	<b>SF 2</b>	<b>15</b>

Pilot: Barsov

A/C: Sukhoi Su-26 RA-30776 Team: RUS



CIVA	Intermediate
Free Known	

Figure K  
200  
Total K  
230

Judges Name	
Signature	Number

Flight #  
**13**

wind/vent **R**

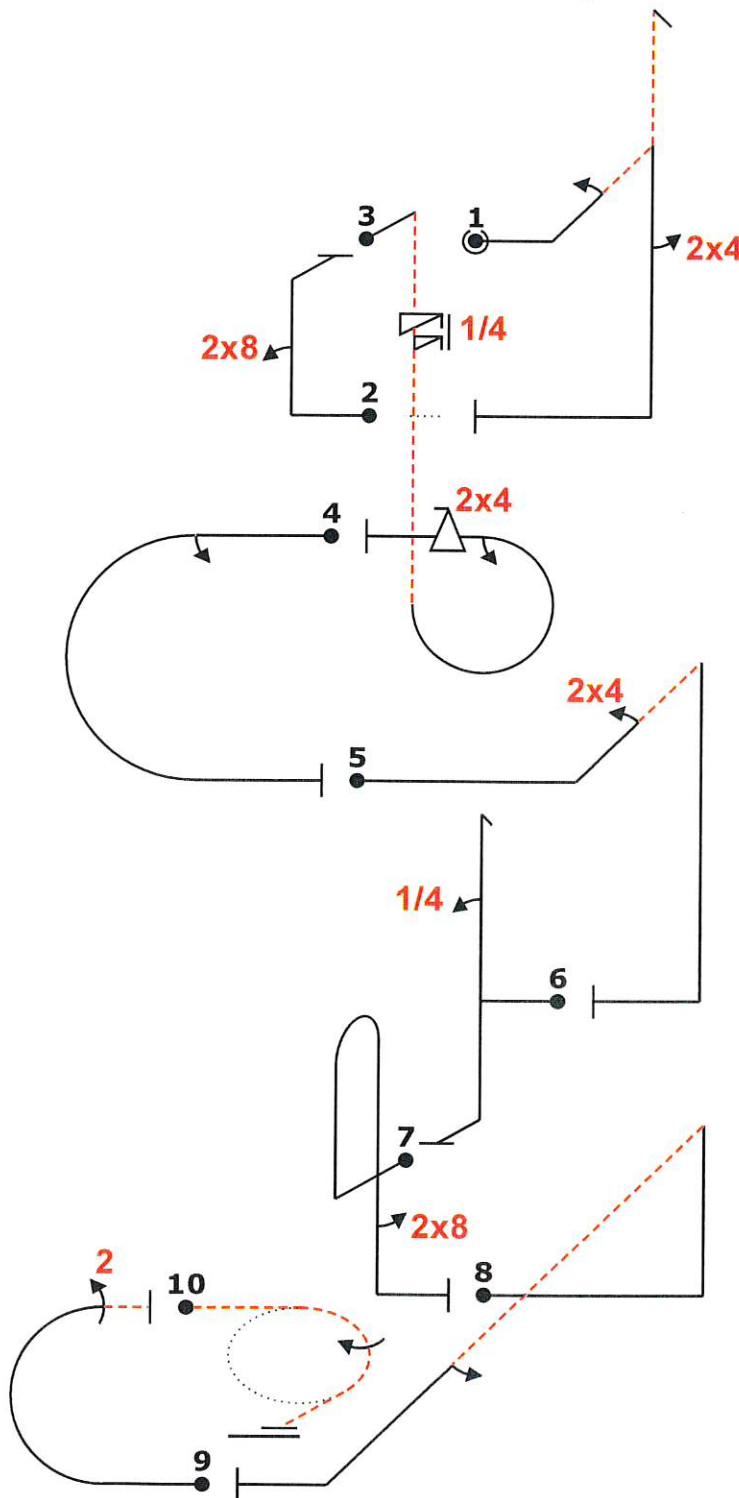

Fig	Grade	Pos	Remarks
1	.		
2	.		
3	.		
4	.		
5	.		
6	.		
7	.		
8	.		
9	.		
10	.		

Positioning  
30 .

Too Low		Trg Violation	
Too High		Wing Rocks	
Interruptions		Disqual Fig	
Insertions		Other(note...)	

zdh'124...1111 (-2,0) v8^ "0A" 115a...11zp1"24,E111 > 8: 2a "0B" ---+134'c..... "0C" 1141h' b.118a'11 --  
++k....211- 3x "0B" m22-11 "0B" -1j1-

Fig 1	K	Fig 2	K	Fig 3 A	K	Fig 4	K	Fig 5 D	K	Fig 6 C	K	Fig 7	K	Fig 8	K	Fig 9 B	K	Fig 10 E	K
5.3.2.1	24	1.1.6.1	10	8.6.4.3	13	7.2.3.3	6	1.2.3.1	12	5.2.1.1	17	8.4.1.1	13	1.2.7.1	13	7.2.1.1	6	2.1.3.2	15
9.1.2.2	6	9.8.1.1	7	9.11.1.5	4	9.1.3.2	4	9.4.2.2	7	9.1.1.1	6	9.8.5.1	3	9.1.4.2	4	9.2.3.4	9		
9.4.5.2	5			9.4.3.2	5														
	35		17	9.9.3.4	11		10		19		23		16		17		15		15

Pilot: STAVILA OCTAVIAN

A/C: E300 L YR-EWH

Team: ROU

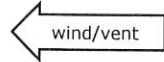

**R**

Figure K  
200  
Total K  
230

Judges Name	
Signature	Number

Flight #  
**14**

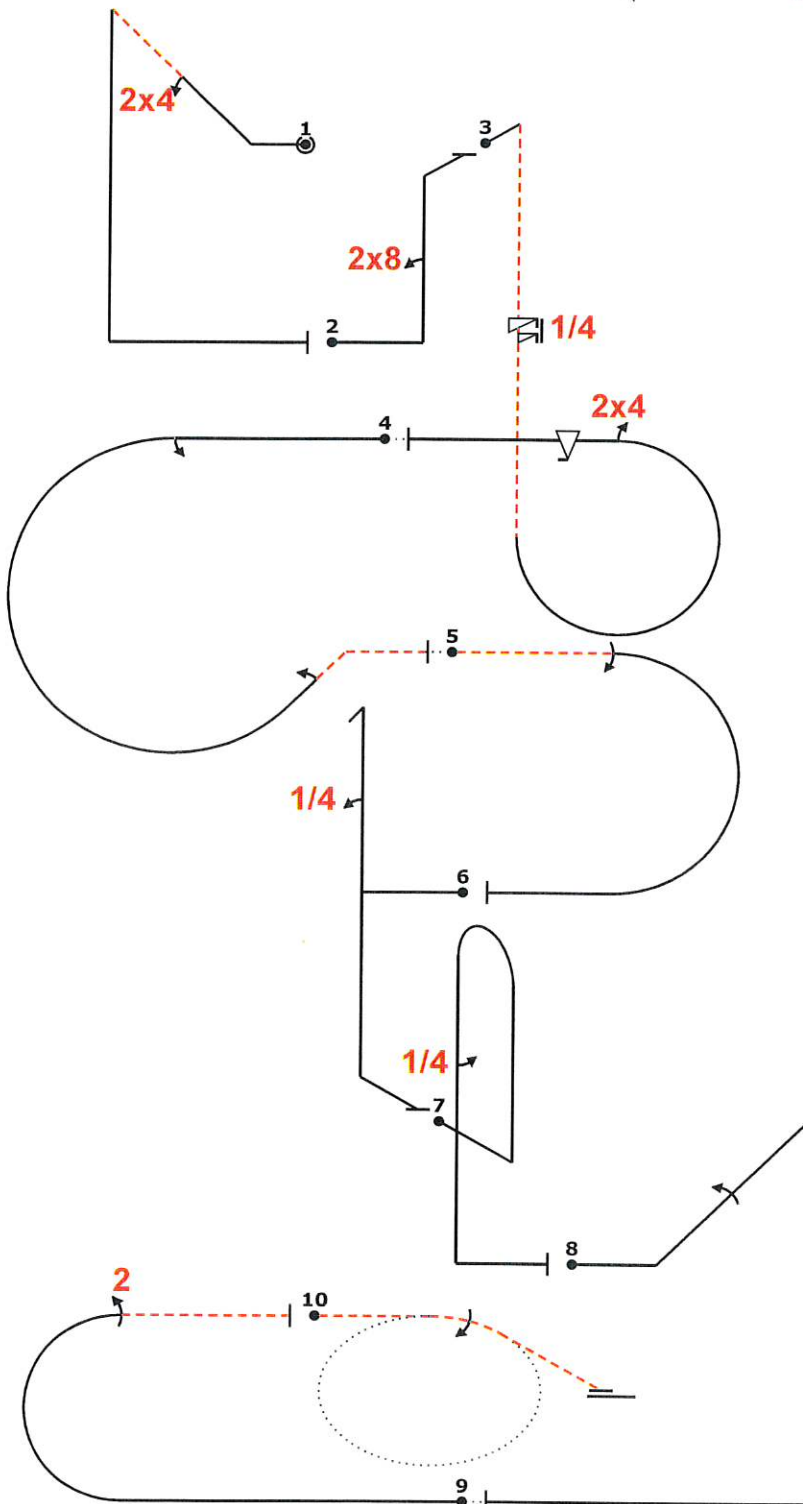

Fig	Grade	Pos	Remarks
1	.		
2	.		
3	.		
4	.		
5	.		
6	.		
7	.		
8	.		
9	.		
10	.		

Positioning  
**30** .

Too Low		Trg Violation	
Too High		Wing Rocks	
Interruptions		Disqual Fig	
Insertions		Other(note...)	

ed "@0" 31% ... +24" t" 8% v8+^ "@A" 11% ... '5s1rp,24,f (2,0) 24% ... 2ic "2" ... (-2,0) 16% - '1a "@C" 10% /4h" 9% '+b" "1"4. "1" 12% +1dh(.)...++~ (2,0) "@B" 10% ... "m22-- "GE" 13% "-1j1-

Fig 1 D	K	Fig 2	K	Fig 3 A	K	Fig 4	K	Fig 5	K	Fig 6 C	K	Fig 7	K	Fig 8	K	Fig 9 B	K	Fig 10 E	K
1.2.3.1	12	1.1.6.1	10	8.6.4.3	13	8.5.8.3	11	7.2.1.4	6	5.2.1.1	17	8.4.1.1	13	5.3.1.1	18	7.2.1.1	6	2.1.3.2	15
9.4.2.2	7	9.8.1.1	7	9.11.1.5	4	9.1.3.2	4	9.1.3.4	8	9.1.1.1	6	9.1.5.1	2	9.1.2.4	10	9.2.3.4	9		
	<b>19</b>		<b>17</b>	9.4.3.2	5	9.1.2.2	6												
				9.9.3.4	11														
					<b>33</b>		<b>21</b>		<b>14</b>		<b>23</b>		<b>15</b>		<b>28</b>		<b>15</b>		<b>15</b>

Pilot: PATRYK OLOS

A/C: EXTRA 330 LC SP-DMK Team: POL



CIVA	Intermediate
Free Known	

Figure K  
200  
Total K  
230

Judges Name		Flight #  <b>15</b>
Signature	Number	

wind/vent **R**

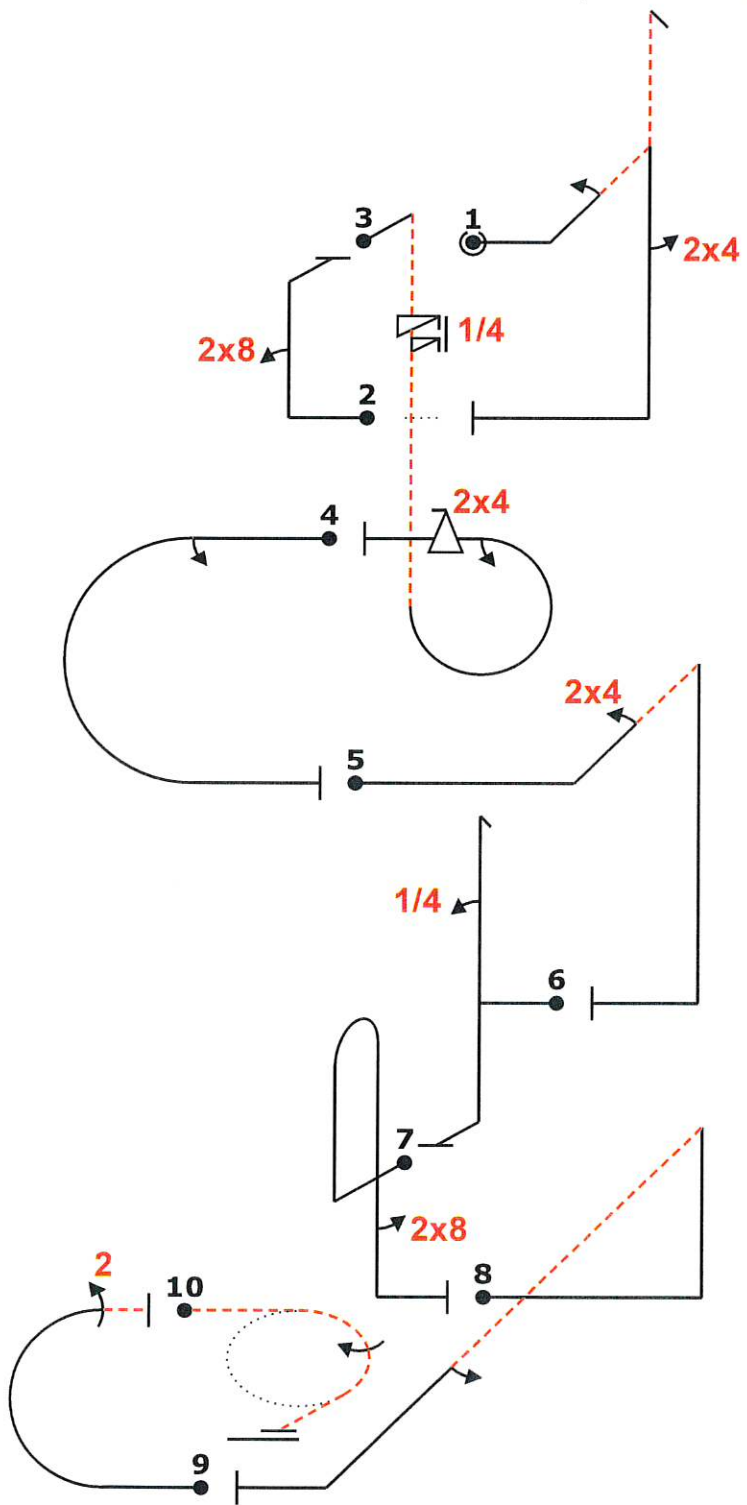

Fig	Grade	Pos	Remarks
1	.		
2	.		
3	.		
4	.		
5	.		
6	.		
7	.		
8	.		
9	.		
10	.		

Positioning  
30

Too Low		Trg Violation	
Too High		Wing Rocks	
Interruptions		Disqual Fig	
Insertions		Other(note...)	

2dhf24... (-2,0) v8 "8A" "5s... "24,Er" > 8s 2a "8D" ... "8C" "15th" p... "8" ... "3s" "8B" m22- "8E" -1j1-

Fig 1	K	Fig 2	K	Fig 3 A	K	Fig 4	K	Fig 5 D	K	Fig 6 C	K	Fig 7	K	Fig 8	K	Fig 9 B	K	Fig 10 E	K
5.3.2.1	24	1.1.6.1	10	8.6.4.3	13	7.2.3.3	6	1.2.3.1	12	5.2.1.1	17	8.4.1.1	13	1.2.7.1	13	7.2.1.1	6	2.1.3.2	15
9.1.2.2	6	9.8.1.1	7	9.11.1.5	4	9.1.3.2	4	9.4.2.2	7	9.1.1.1	6	9.8.5.1	3	9.1.4.2	4	9.2.3.4	9		
9.4.5.2	5			9.4.3.2	5														
	<b>35</b>		<b>17</b>	9.9.3.4	11		<b>10</b>		<b>19</b>		<b>23</b>		<b>16</b>		<b>17</b>		<b>15</b>		<b>15</b>

Pilot: CAVAL MIHAI-VALENTIN

A/C: E300 L YR-EWF

Team: ROU

03/09/2021, 1



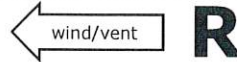

Figure K  
200

Total K  
230

Judges Name	
Signature	Number

Flight #  
**16**

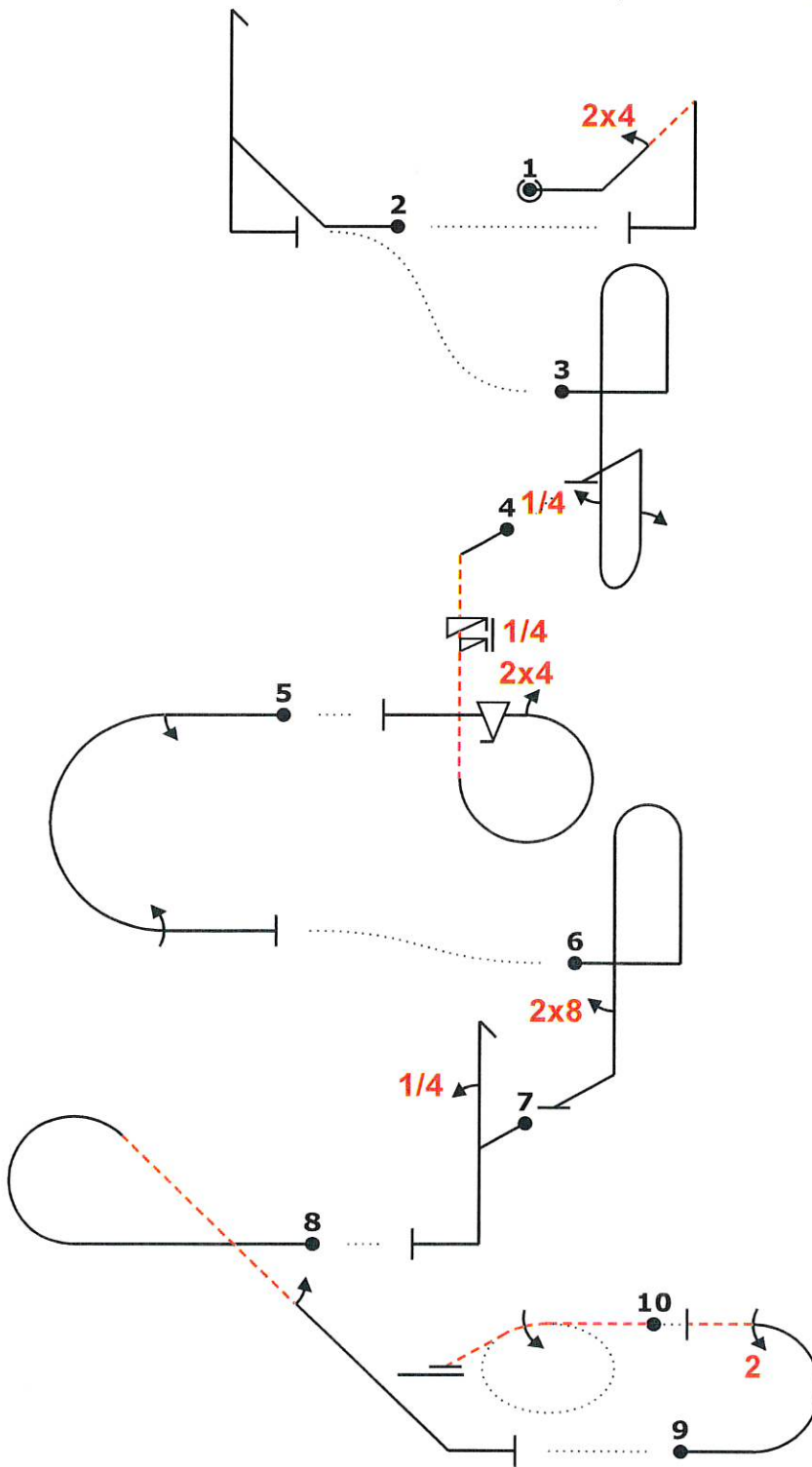

Fig	Grade	Pos	Remarks
1	.		
2	.		
3	.		
4	.		
5	.		
6	.		
7	.		
8	.		
9	.		
10	.		

Positioning  
30

Too Low		Trg Violation	
Too High		Wing Rocks	
Interruptions		Disqual Fig	
Insertions		Other(note...)	

"@0" 24t (-10,0) dh (12,10) bb(.,4),2 (-1,1) "0A" 5sirr,24,f> (-2,0) 7% 2a1 (14,2) b. "' ,8 "0C" 4h> (-2,0) c...  
..2.' (6,0) "0B" m22- (2,0) "0E" -1j1-

Fig 1 D	K	Fig 2	K	Fig 3	K	Fig 4 A	K	Fig 5	K	Fig 6	K	Fig 7 C	K	Fig 8	K	Fig 9 B	K	Fig 10 E	K
1.2.3.1	12	5.3.1.1	18	8.8.2.1	19	8.6.4.3	13	7.2.3.3	6	8.4.1.1	13	5.2.1.1	17	8.5.6.1	10	7.2.1.1	6	2.1.3.2	15
9.4.2.2	7			9.1.5.1	2	9.11.1.5	4	9.1.3.2	4	9.8.5.1	3	9.1.1.1	6	9.1.4.2	4	9.2.3.4	9		
				9.1.1.2	8	9.4.3.2	5	9.1.3.4	8										
				9.9.3.4	11														
	19		18		29		33		18		16		23		14		15		15

Pilot: Dan Stefanescu

A/C: Su 31 N131BT

Team: ROU





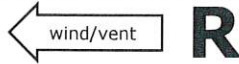

Figure K  
200  
Total K  
230

Judges Name	
Signature	Number

Flight #  
**18**

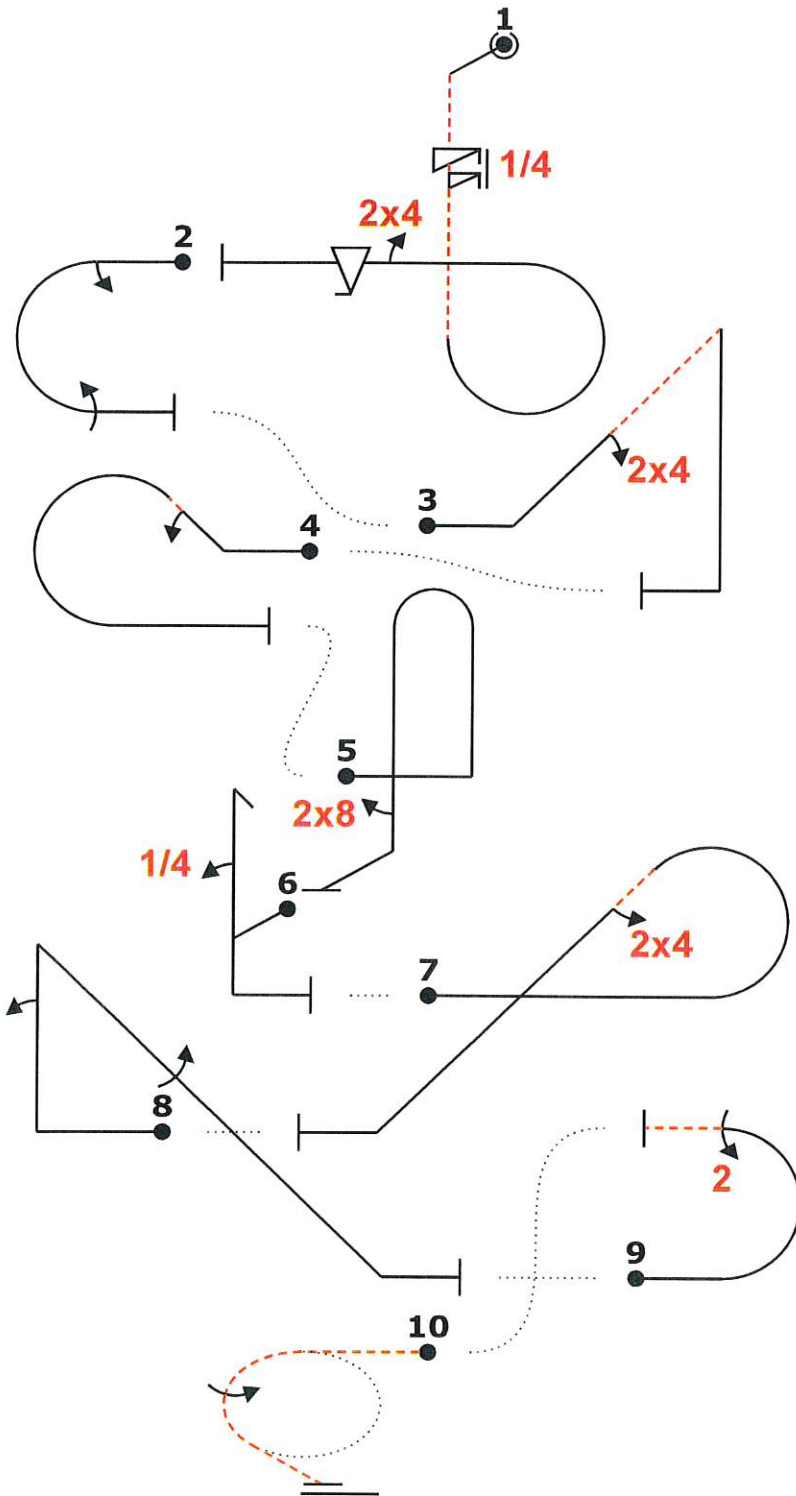

Fig	Grade	Pos	Remarks
1	.		
2	.		
3	.		
4	.		
5	.		
6	.		
7	.		
8	.		
9	.		
10	.		

Positioning  
30

Too Low		Trg Violation	
Too High		Wing Rocks	
Interruptions		Disqual Fig	
Insertions		Other(note...)	

ej "8A" 5sirr... ,24, f> 2al (9,6) "8D" ..,24.'t.. (-13,-2) .....2"rc ..... (0,8) b.' ,8 "8C" 4h" (2,0) c  
24...' (-3,0) ~'2'k''1..' (5,0) "8B" m22- (-7,12) "8E" /-1j1-

Fig 1 A	K	Fig 2	K	Fig 3 D	K	Fig 4	K	Fig 5	K	Fig 6 C	K	Fig 7	K	Fig 8	K	Fig 9 B	K	Fig 10 E	K
8.6.4.3	13	7.2.3.3	6	1.2.3.1	12	8.5.2.1	10	8.4.1.1	13	5.2.1.1	17	8.5.6.1	10	1.2.6.1	14	7.2.1.1	6	2.1.3.2	15
9.1.1.1.5	4	9.1.3.2	4	9.4.2.2	7	9.1.2.2	6	9.8.5.1	3	9.1.1.1	6	9.4.4.2	5	9.1.1.2	8	9.2.3.4	9		
9.4.3.2	5	9.1.3.4	8											9.1.4.4	8				
9.9.3.4	11																		
<b>SF 3</b>	<b>33</b>	<b>SF 7</b>	<b>18</b>	<b>SF 7</b>	<b>19</b>	<b>SF 7</b>	<b>16</b>	<b>SF 7</b>	<b>16</b>	<b>SF 5</b>	<b>23</b>	<b>SF 7</b>	<b>15</b>	<b>SF 7</b>	<b>30</b>	<b>SF 7</b>	<b>15</b>	<b>SF 2</b>	<b>15</b>

Pilot:

Vasilyev

A/C: Sukhoi Su-26 RA-30776 Team: RUS



